

Инструкция по установке **Mitsubishi Pajero IV** (2007-2020)

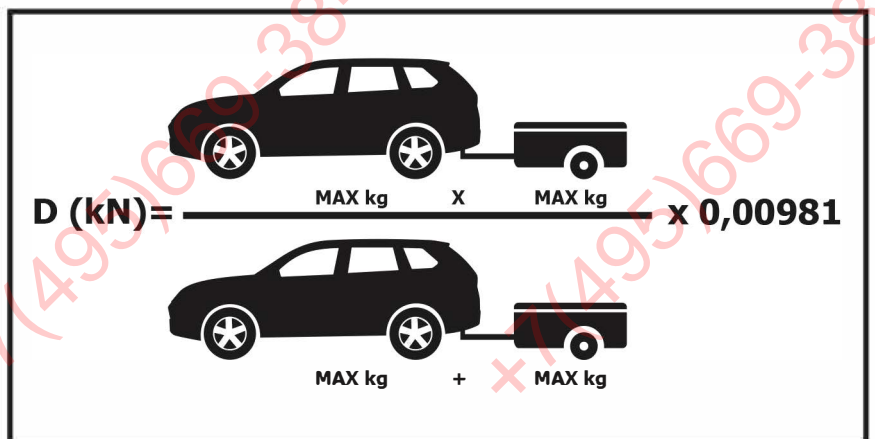

Арт.: F.4011.001

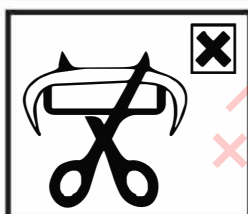

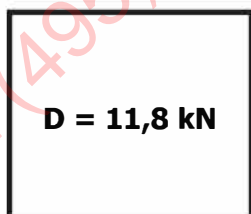
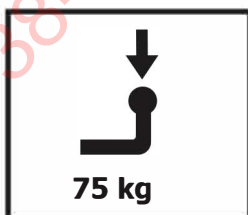
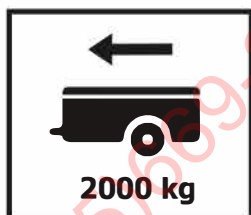
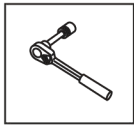

Вкрутить/выкрутить используя инструмент

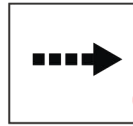

Движение

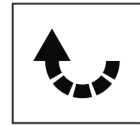

Поворот



Вкрутить/выкрутить не затягивая

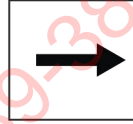



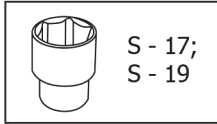
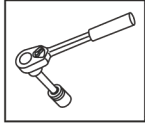

Расположение

Используемый инструмент:

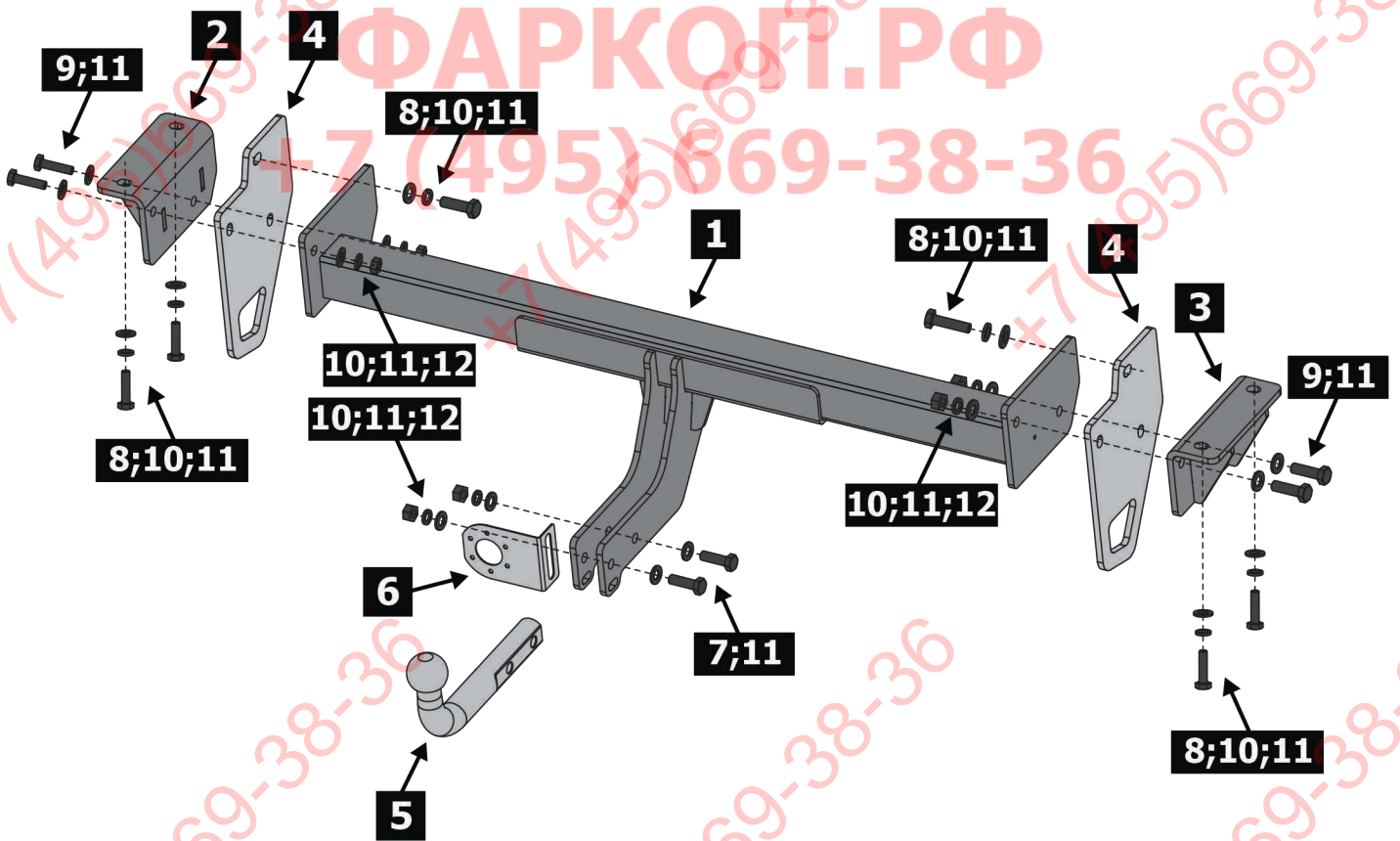

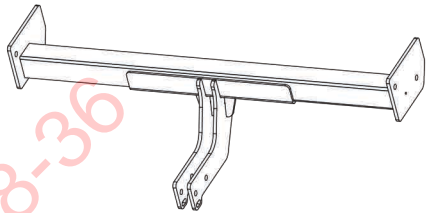
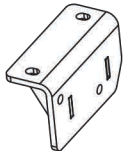
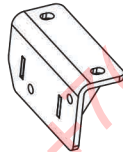
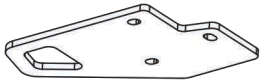
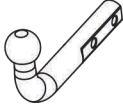
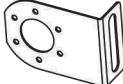
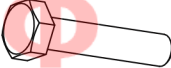
S - 17;
S - 19

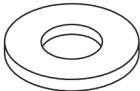
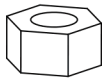

1	x1	Балка	
2	x1	Кронштейн левый	
3	x1	Кронштейн правый	
4	x1	Кронштейн балки	
5	x1	Крюк	
6	x1	Подрозетник	
7	x2	M12x1,25x70	
8	x6	M12x1,25x35	
9	x4	M12x1,25x45	
10	x12	Ø 12	
11	x18	Ø 12	
12	x6	M12x1,25	

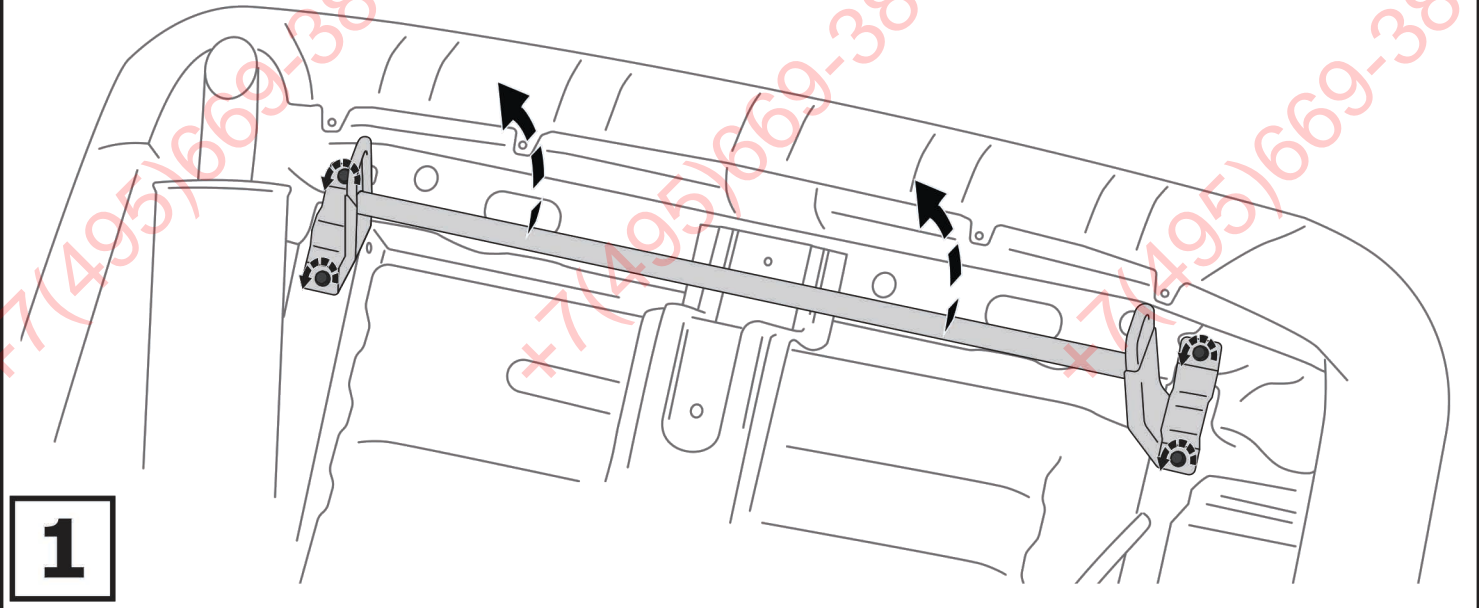

1

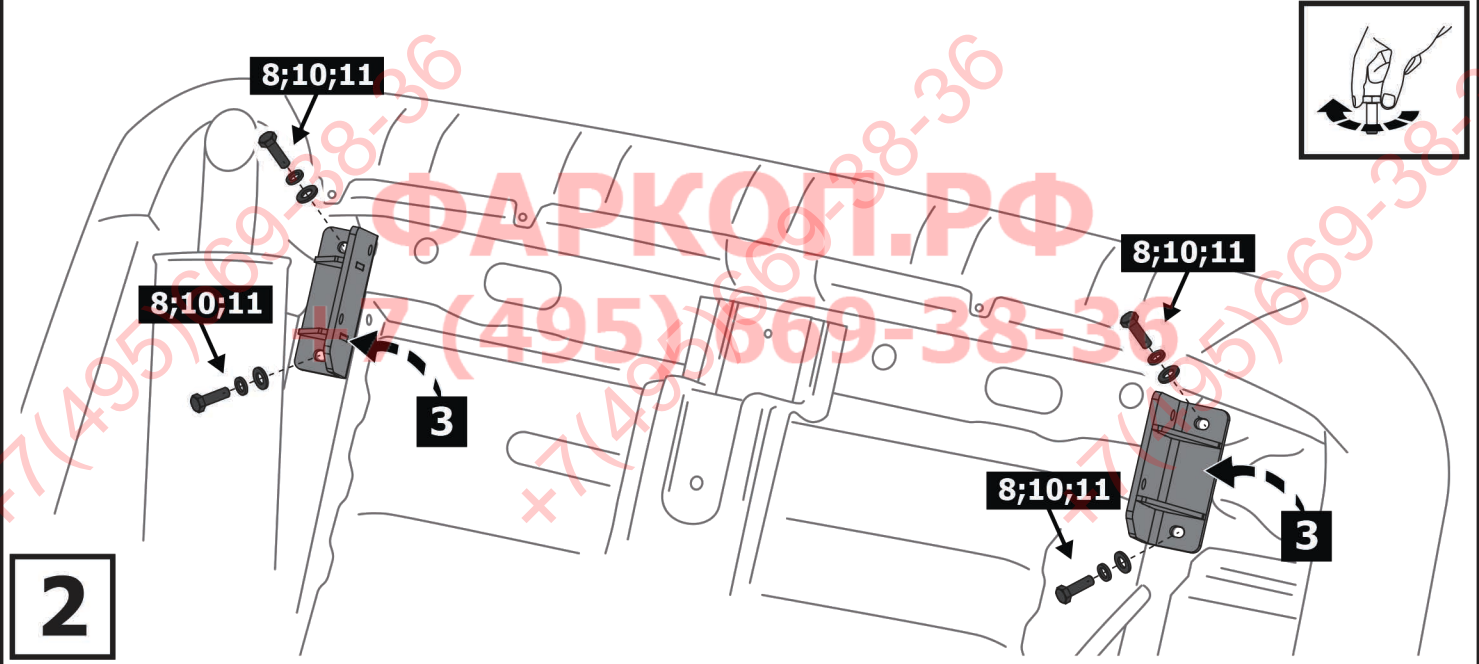

2

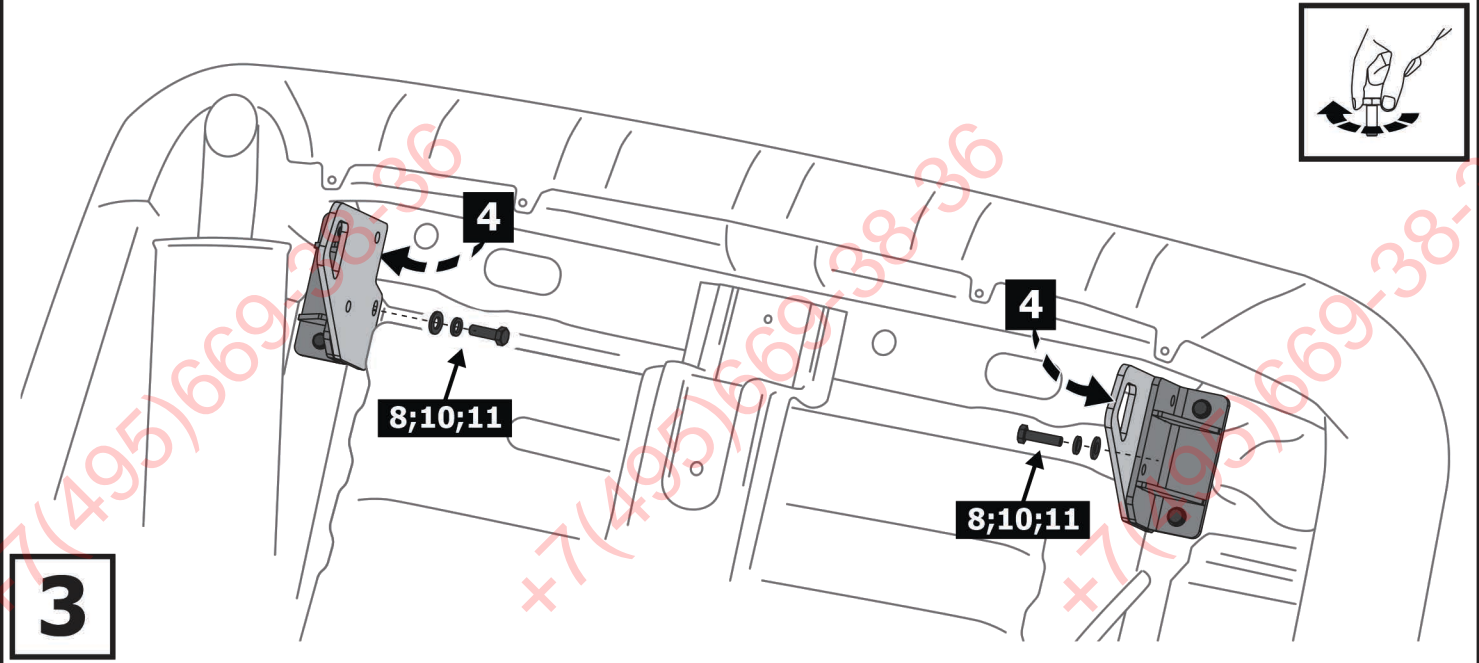

3

